



MBA

Mediablaster®
Cabinets By:

MEDIA BLAST®

591 W. Apollo St., Brea CA.
92821 (714) 257-0484
www.mediablaster.com

OPERATOR'S MANUAL CrystalBlast Pro Stage II



MANUAL COLOR CODES:

Very Important – **Important** – Please review all informaton prior to operation

NEW PRO STAGE II MACHINE QUICK OPERATION SHEET

Please review all the manual carefully before using. This sheet is the fast operation sheet you can use if already familiar with Pro Sandcarver Operation.

1. Unpack and place the machine installing any parts packed inside the cabinet for user assembly, this includes the padded armrest, casters and foot operated blast pedal all packed inside the cabinet after testing, this requires some simple quick assembly by the user
2. Open the dust collector access door and check the filter cartridge for tightness, see main manual
3. With the main air inlet valve closed, attach compressed air to the air inlet valve making sure line pressure is 90 to 100 psi, attaching a line pressure gauge before the air inlet is advised
4. Plug the machine into dedicated 120 volt 20 amp service outlet, do not use extension cords
5. Turn on the lights and blower using the machine ON-OFF selector switch
6. Open the main air inlet valve and set the air regulator at 30 psi blasting pressure, you will hear the pot valve close at this time
7. Close the main air inlet valve and press down and hold the installed blasting pedal to remove all the air from inside the pressure pot. You watch the air pressure gage as the pot empties, you will hear a metallic sound when the pot valve opens. The pot valve must be open to allow new abrasive to fill the pot
8. Open the right side machine access door and pour 30 pounds of quality abrasive inside the main machine hopper. When first charging, pour abrasive into the middle of the work grate. Because the pot valve is open at this time the abrasive will fill the pot
9. With the foot valve installed, the On-Off Switch turned to the ON position, and the air regulator already set for 30 psi, quickly open the main air inlet valve. Make sure you have 90 to 100 psi line pressure into the cabinet at this time. Opening the main air inlet valve will close the pressure pot valve automatically and also close the On-Off abrasive flow control pinch valve holding pressure inside the pot
10. Wearing a pair of supplied disposable gloves, place hands into the operator ports then pick up the blasting nozzle holding like any pencil with thumb and index finger pointed at the part. This will also point the nozzle at the part
11. Press down and hold the blast pedal. Blast will start at this time, release the blast pedal to end blast. Always allow about 2 seconds to clear the abrasive hose and start even flow
12. See manual for adjustment of even abrasive flow using the Choke Flow Control Valve if required
13. If the blasting has ended for the day, turn off the blower and open the ball valve operating the dust collector pneumatic vibrator. Let the vibrator operate for 2 to 3 minutes.
14. Turn on the blower, close main air inlet valve, press and hold blast pedal down to depressurize pot allowing all compressed air to exit the pot using the blast nozzle. Do this to end the blast session for the day, always depressurize the pot when the air compressor is going to be turned off for the day
15. For the first full week of operation, use open hand to slap the bottom of the dust collector access door. With the blower off, slowly open the door and view the condition of the filter cartridge. Getting familiar with the visual condition of the filter is important to understanding possible problems like wet air or uncleaned dust collector filter cartridge, see manual. The DDC, Daily Duty Cycle, can be know determining the machine daily cleaning cycles required if you simply monitor the dust collector filter for one week



MBA

Mediablaster®
Cabinets By:

MEDIA BLAST®

591 W. Apollo St., Brea CA.
92821 (714) 257-0484
www.mediablaster.com

PLEASE READ THROUGH THIS MANUAL BEFORE OPERATION
MAXIMUM MACHINE INLET PRESSURE 125 PSI
MINIMUM LINE PRESSURE 90 PSI for OPERATION OF THE MACHINE CONTROLS

Always observe all OSHA Codes for Machine Service and Maintenance regarding Electrical and Air Lock-Outs and Lock-Out Tags

QUICK OPERATION SHEET

The information that follows will be used to get your new CrystalBlast Pro Stage II machine setup and running in the shortest period of time. Use this sheet for the initial machine set-up and operation. You may refer to this sheet at any time, for more detailed operation instructions refer to the main operation manual in this manual.

FIRST

- To remove the machine from the shipping pallet, first remove the screws holding the cardboard box to the wooden pallet. Lift the box off over the top of the machine, if you do not have adequate vertical height, cut the box open at one of the corners and remove. When wood crated, use gloves and eye protection to remove the wooden crate. Most machines are shipped in wooden crates. This requires disassembly of the crate, care must be taken when removing crated machines.
- Remove the four 3/8" lag-bolts located one at the bottom of each leg. If equipped, do not remove the unpainted, temporary front leg support until the machine has been placed in its final location, this brace allows pallet jack lifting. Machines may be shipped with strapping over the pressure pot flange for stability. This strap is under extreme tension so always wear safety glasses and gloves when removing these shipping straps.
- **THIS MACHINE WEIGHS 400 POUNDS SO USE CAUTION WHEN LIFTING OFF THE PALLET AND MOVING. MBA RECOMMENDS THE USE OF AT LEAST FOUR PEOPLE WHEN REMOVING THIS MACHINE FROM THE PALLET.**

NOTE:

If this machine is equipped with rear mounted dust collector it will include a stability leg design, care should always be taken when moving the machine to ensure the machine is always stabilized during any machine movement before activating the stability leg. Only cabinets with the rear mounted dust collector will have the stability leg. Once placed, unscrew the two bolts holding the leveling insert allowing it to drop down. The insert leg will drop down to the floor, at that time; retighten the insert to hold in position. If the model includes a front unpainted leg brace, this brace is a temporary shipping brace only and should be removed once the machine is placed in final position. This leveling leg does not apply to side-mounted dust collectors allowing the use of machine casters.

- Standing at the front of the machine, remove the machine using four people to slightly lift the machine vertically off the pallet just enough to pull the machine until the first two legs touch the ground. **BE CAREFUL NOT TO LET THE PNEUMATIC PINCH VALVE WITH MICRO AIR FILTER HIT THE PALLET WHEN PULLING THE MACHINE (SEE PAGE 5 ITEM G).** Lightly set the first two legs on the ground but, do not let the machine slam down hard. Stage II models include machine casters, two locking and two stationary. Assembly will be required after the machine has been set on the floor. Lift one side of the cabinet, block up, and install the side front and rear casters. Next block the other side up, and install the other side front and rear casters. Media Blast advises installation of the two locking casters on the two front legs.
- Use the caster equipped machine to move the cabinet into final position.
- **THIS MACHINE WEIGHS 400 POUNDS SO USE CAUTION WHEN LIFTING OFF THE PALLET AND MOVING.**

After the machine has been placed into position follow the steps listed below:

- Remove all items from inside the cabinet. The Foot Pedal Valve is a normally open 3-way valve; air will flow through the valve and close the on-off Pneumatic silver metal Pinch Valve when the main air inlet valve is opened, air will also close the pot valve and close the pinch valve at the same time holding air inside the pot. The foot valve is packed inside the cabinet. **The two air lines are marked and must be installed into the right location.** One line presses into the micro filter on the Silver pinch valve at the bottom of the pressure pot, the other inserts into the Tee just after the Main Air Inlet Valve. After air has been supplied and the main air valve has been opened, pressing down on the Foot Pedal will open the pinch valve allowing air blast to occur, no abrasive has been added to the pot at this time, releasing the foot valve will stop the blast. **You must depressurize the pressure pot to load abrasive into the pot the first time but set the regulator at 30 psi at this time. To depressurize the pot, close the main air inlet and pressure down on the blast pedal until you hear the metallic sound of the pot valve opening. This requires all the air be drained from the pot first and may take 30 seconds. You can see the air leaving by watching the regulator pressure gauge.**
- The Pro Stage II Model includes the padded armrest standard and need to be attached using the supplied hardware. Always place the round headed bolts on the outside of the cabinet. Four Casters, two locking, have been supplied for user assembly. Lift one side and block up using a stretcher spacer under the stretcher. With adequate space install the front locking and rear swivel caster. Lower and repeat for the second side.

- Attach the compressor air supply line to the machine at the Main Air Inlet Valve, **Item B Pneumatics Reference Diagram**, attached to the Air Regulator Control Cluster that includes the air regulator-filter-water trap and air pressure gage. Make sure the main air inlet valve is closed at this time. **The machine has been shipped without fittings in the main air inlet to allow the customer to maintain shop uniformity by installing matching fittings already used at their facility.** Match the air inlet fitting to the size of the Main Air Inlet Valve or use a plumbing reducer bushing if needed. **Using a small air supply hose, long supply hose, coiled air hoses and or multiple quick-connectors is not advised, this may cause compressed air flow problems that may affect proper machine operation and the combination of variables to too extensive.** Because this is a low-pressure blasting cabinet, and it uses a standard 3/32" nozzle, using one quick disconnect fitting is OK at the main air ON-OFF control valve.
- Release the power cord, 120 volt 3-prong, and plug into a standard 120 volt 60Hz **service outlet, dedicated service.** The running amperage of this machine is **7.6 Amps or 910 Watts.** Any dedicated single service outlet will operate the machine. This machine includes a 1/2 HP blower motor assembly, any blower will draw higher amperage during RPM start up, a spike, and the service outlet must be dedicated service only. The use of extension cords is not recommended, however **if you have to use an extension cord, make sure the cord amperage is adequate for the machine amperage rating.** All extension cords have a printed maximum amperage rating listed on the cord. **Never use extension cords over 15 feet** when using any 1/2 HP blower motor operated blasting cabinet. **If the panel circuit breaker trips at any time when the blower is starting up, the service is not dedicated allowing the addition of 7.6 running amps with blower start up and, a new dedicated circuit must be installed.**
- Using the machine on-off switch located on the left side of the light housing, turn the dust collector blower and lighting switch to the on position.

Make sure the air compressor is operating with a minimum line pressure of 90 psi at the cabinet at all times. In order for the air controls to operate correctly, you must supply adequate compressed **air volume and pressure and not just the blasting nozzle pressure.** The CrystalBlast Pro stage II machine requires an **air inlet pressure of 90 psi at all times for proper operation of the machine air controls.** **Always close the Main Air Inlet Valve at the end of the day and drain all compressed air from the pressure pot using the blast pedal. Always drain the pressure pot with the machine blower running.** Running the machine blower will prevent abrasive from escaping the cabinet during pressure pot de-pressurization and pot filling.

FILLING WITH ABRASIVE THE FIRST TIME

- **Open the side access door with the blower running, pour only 30 pounds of abrasive onto the middle of the operator work grate** and allow the abrasive to transfer into the pressure pot assembly. The exhaust blower will prevent dust from exiting the cabinet during the filling process. The abrasive will fill the pressure pot directly because pressure pot is not pressurized and the pot valve is open. This means the main air valve into the machine is closed and pot valve open. The pot valve drops down automatically each time you close the main air inlet valve and use the blast pedal to drain the pot pressure. To pressurize the pot after filling simply open the main air inlet valve. This will close the Silver Metal Pinch valve and close the pot valve at the same time.
- With the pot loaded and full of abrasive and the main air valve open, you are ready to check and adjust the blasting pressure again. Normal blasting pressures range from 30-40 psi and it may become necessary to set the regulator again during the blasting process if the pressure falls more than 10%. The type and length of the air supply line used to connect the compressed air to the machine often creates a pressure drop at the regulator during machine operation making a final regulator adjustment necessary when undersized air lines are too long. The resting pressure after adjustment change, when the blast is off, this will then become what is required for any blasting pressure based on machine set-up, installation materials and flow restrictions.
- Stepping down and holding down on the Foot Pedal will activate the blast. Releasing the Foot Pedal Valve will stop the blast.

NOTE:

The machine blast can be stopped at any time by releasing the Foot Pedal Valve. Closing the Main Air Inlet Valve will stop the ability of the air to flow into the pressure pot assembly but, pressing down on the blast pedal is required to empty the pressure pot of compressed air.

ADJUSTING THE ABRASIVE FLOW

Adjusting the abrasive flow is simple. Locate the Abrasive Choke Valve on the bottom right side of the pressure pot. Set the valve at 45-degrees valve open. When the valve is completely open, parallel to the air hose, you will see very little abrasive exiting the nozzle. Adjust as follows but, **never close the choke valve completely:**

- Set the Abrasive Choke Valve at 45 degrees and test for blast by pressing down on the Foot Pedal Valve. **Main air supply must be open with the pot valve closed.** If very little abrasive is exiting the nozzle after 2-3 seconds, move the valve more to the closed position using small handle movements of only 1/4". Just before the nozzle is delivering the proper amount of abrasive, the abrasive flow will pulse slightly. Close the Abrasive Choke Valve a bit more and the pulsing will disappear, the setting is now correct, closing the choke valve more will cause erratic pulsing of the flow to the nozzle. This setting will stay correct unless you change the blasting pressure or abrasive mesh size. Remember abrasive will wear during use, to a smaller size, if pulsing does start to occur, readjust the valve making small movement of the handle towards open to lesson abrasive flow. This adjustment will slow the abrasive delivery to the nozzle.

Always, shut off the Main Air Inlet valve at the end of daily operation or when the air compressor will be turned off. Depressurize the pot assembly when the air compressor is going to be turned off for the day by closing the Main Air Inlet Valve and pressing down on the blast pedal until all air has been released from the pot and the pot valve opens.

QUICK OPERATION GUIDE	1-3
INDEX	4
CrystalBlast Pro Stage II Operation and Maintenance Control Diagram.....	5
CrystalBlast Pro Pneumatics Reference Diagram.....	6
IMPORTANT INFORMATION	7
GETTING STARTED	8
Installing the Machine.....	8
Unit Placement.....	8
Installation of Foot Pedal Valve.....	8
Electrical Requirements and Connection.....	8
Air Requirements and Connection.....	8
Changing the Abrasive Hose Location.....	8-9
Selecting the Right Abrasive.....	9
Loading the System with Abrasive.....	9
Filling the Blast Pot.....	9
Adjusting the Blast Pressure.....	9-10
Adjusting the Abrasive Flow.....	10
Wearing Gloves.....	10
Ready to Blast.....	10
Finishing Blast.....	10
CFM Air Consumption Chart.....	10
Cleaning the Dust Collector.....	11
MAINTENANCE	11
General Maintenance Interval Chart.....	11
Cleaning the Abrasive Scalper Screen.....	11
Cleaning the Dust Collector Bag Filters.....	11
Removing the Dust From the Dust Collector.....	11-12
Inspecting and Replacing the Blast Nozzle.....	12
Replacing the Blast Hose.....	12
Replacing the Light Bulbs.....	12
Replacing the Window Protector or View Window.....	12
Replacing the Dust Collector Bag Filters.....	12-13
Replacing the Pneumatic Pinch Valve Bladder.....	13
Draining the Blast Pot and Replacing with New Abrasive.....	13-14
Replacing the Blast Pot Seal or the Pot Plunger.....	14
TROUBLE SHOOTING	15
Will Not Blast: Compressed Air but No Abrasive.....	15
Will Not Blast: No Compressed Air or Abrasive.....	15
“V” Blast Pattern From Nozzle.....	15
Blast Will Not Stop.....	16
Erratic Abrasive Delivery From Nozzle.....	16
Large Surge of Abrasive at the Beginning of Blast.....	16
Air Leak Heard when Refilling the Blast Pot with Abrasive.....	17
Blast Pot Will Not Seal.....	17
System Won’t Maintain Desired Blast Pressure.....	17
Operator Getting Shocked by Machine.....	17
Abrasive and/or Dust is Coming Out of the Exhaust Blower Silencer.....	18
SYSTEMS DIAGRAMS AND PARTS LIST	20
CrystalBlast Pro Parts Diagram.....	21
CrystalBlast Pro Parts List.....	22
Electrical	23
WARRANTY	24



OPERATION AND MAINTENANCE DIAGRAM Pro Stage II

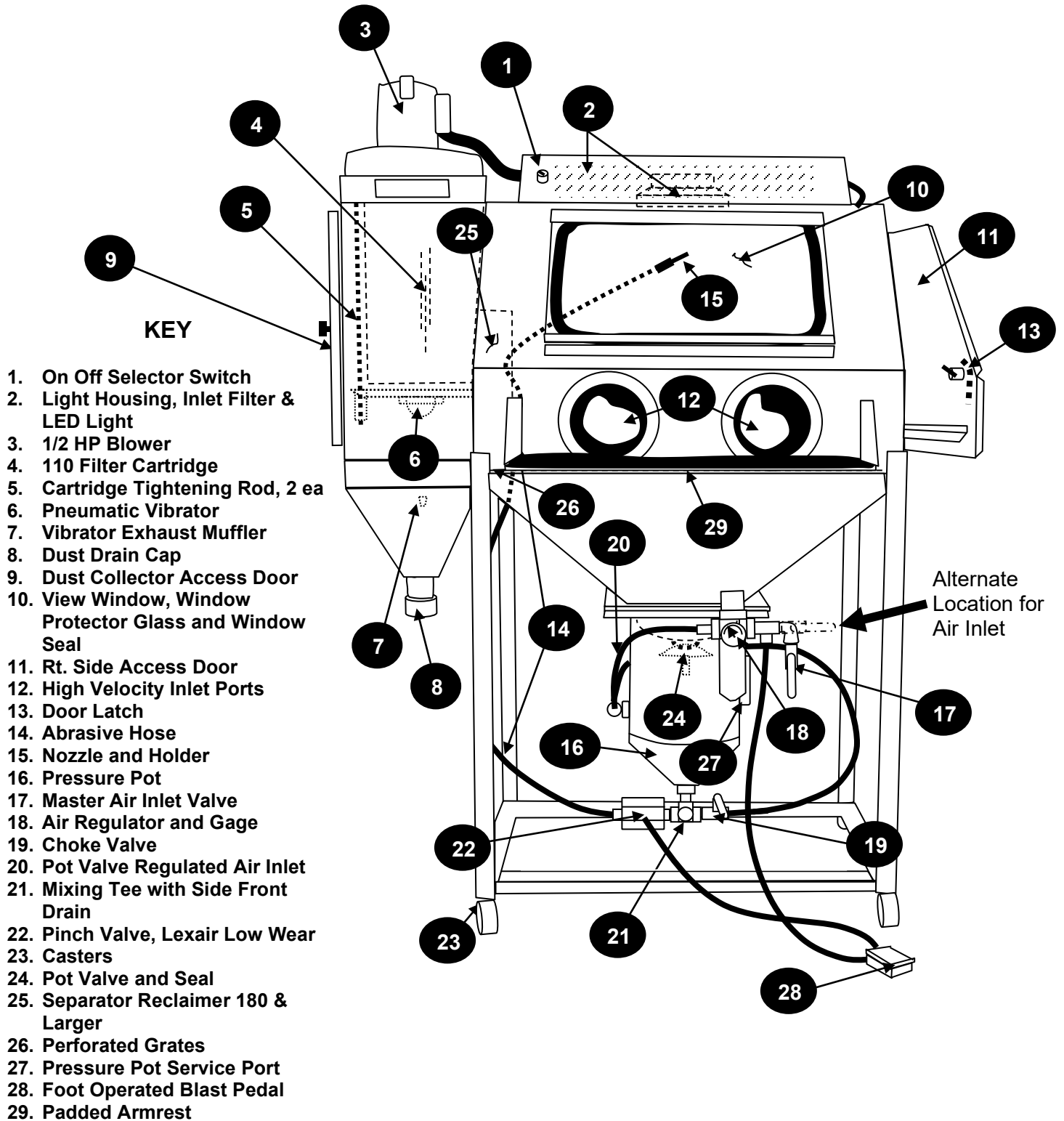

CrystalBlast Pro Stage II Pneumatics Reference Diagram

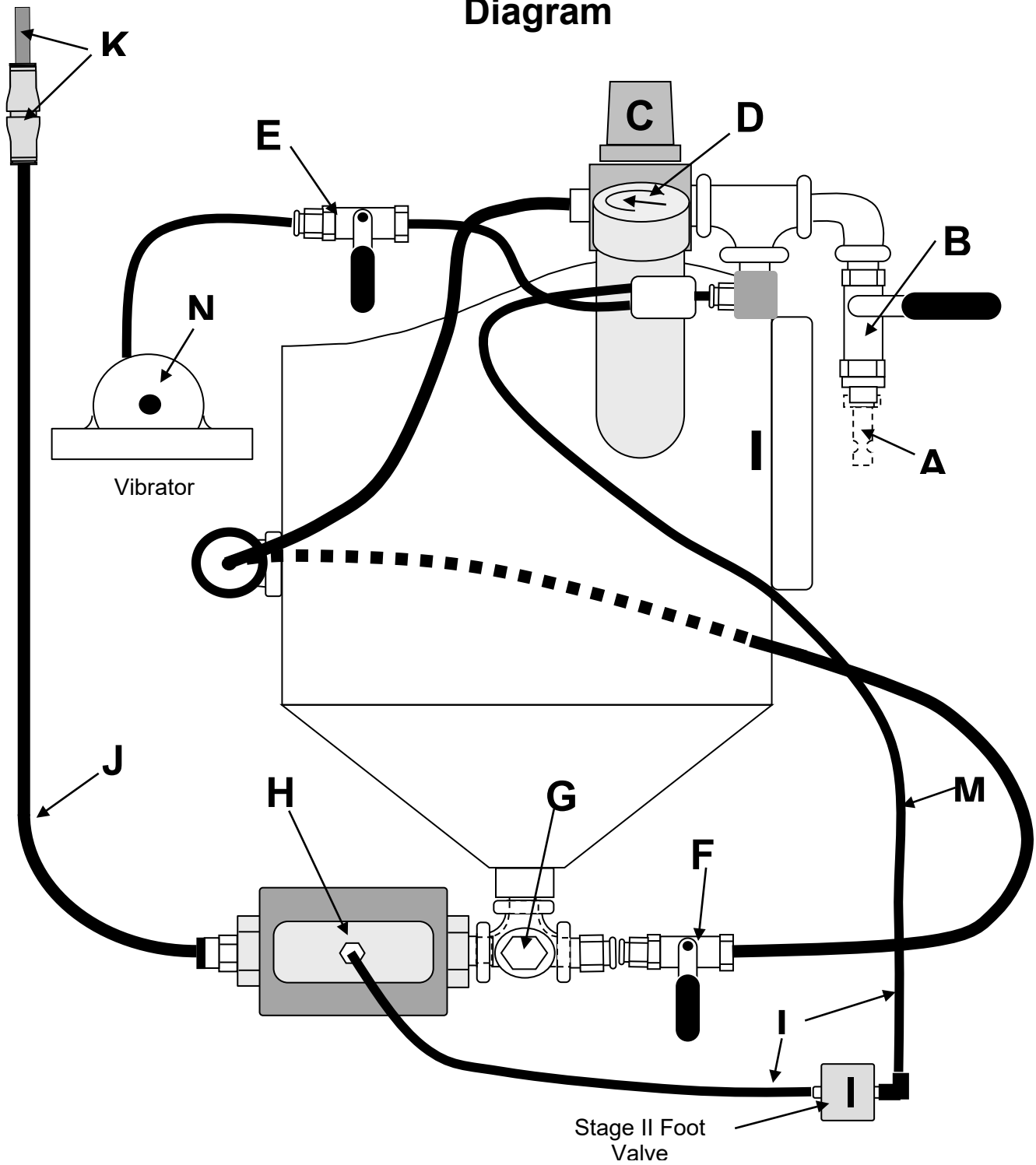

KEY

KEY

- A. Air Inlet Quick-Disconnect Fitting (not supplied)
- B. Main Air Inlet Valve
- C. Air Regulator Control Knob
- D. Air Pressure Gauge
- E. Vibrator Ball Valve
- F. Abrasive Choke Valve
- G. Abrasive Mixing Tee, Side Drain
- H. Pneumatic Pinch Valve w/ micro air filter
- I. Foot Pedal Valve, 3-way
- J. Abrasive Hose
- K. Nozzle and Nozzle Holder
- L. Foot Pedal Valve Tubing, 1/4" Line Pressure
- M. Line Pressure Through 3-Way Foot Valve N/O
- N. Dust Collector Vibrator

125 MAXIMUM INLET PRESSURE



IMPORTANT INFORMATION

Welcome to the CrystalBlast Family! You have just purchased the CB Pro Stage II Sandcarving cabinet. This machine is designed, built, manufactured and assembled in the USA by Media Blast & Abrasive Inc. Established in 1977 and building fine abrasive blasting equipment for over 43 years.

Always observe all OSHA Codes for Machine Service and Maintenance regarding Electrical and Air Lock-Outs and Lock-Out Tags..

This machine is very easy to operate and maintain. However, there are several important issues of which you should be aware:

- ❖ **CHECK THE DUST COLLECTOR FILTER FOR TIGHTNESS ON ALL NEW MACHINES.** Truck freighting is not gentle, always open the dust collector access door and using two hands open on both sides of the filter top sides, try and gently push the filter front to back. If the filter moves, tighten the two holding knobs and jam nuts on the filter rods, one on each side of the filter cartridge, making sure to tighten the jam nut against the knob. Do this until the filter does not move with gentle pushing. Do not overtighten the filter and crush the filter pleats.
- ❖ **ALWAYS USE CLEAN, DRY COMPRESSED AIR.** Moisture will cause abrasive to stick together preventing flow. Your CrystalBlast Pro model is equipped with a single pneumatically cleaned 110 sq.ft. filter cartridge. What any dry dust collector does not like is wet air or oily parts. Install a dryer if air entering the cabinet is hot.
- ❖ **FOR PROPER OPERATION, THE STANDARD 3/32" i.d. NOZZLE REQUIRES 5.7 CFM OF COMPRESSED AIR @ 30 psi).** Make sure that your air compressor exceeds this requirement by at least 75%, it is possible a worn nozzle will not maintain the 90 psi required to operate the air controls. Premature compressor failure can be a secondary result of using a marginally sized air compressor. The 3/32" nozzle is recommended for operation using 9-10 cfm compressor volume. **Always look at cfm volume of any compressor at 90-100 psi not displacement at 0 psi in the tank.**
- ❖ **DO NOT BLAST ABOVE 60 PSI.** This machine is designed for operation at low pressures. Blasting at pressures in excess of 60 psi will lead to premature breakdown of the abrasive and premature failure of wear components (blast hose, blast nozzles, window protector etc.). This Pro model includes the high pressure long wear abrasive control features but, an upgraded boron carbide nozzle is available for pressures on the high side.
- ❖ **ALWAYS DEPRESSURIZE THE POT AT THE END OF THE DAY.** It is necessary to depressurize the pot prior to turning off the air compressor. The nozzle will begin blasting once the line pressure drops to regulator blasting pressure. Also, the next time the air compressor is turned on, the system will immediately begin blasting until the air compressor builds up adequate air pressure for proper air control operation.
- ❖ **REGULARLY CHECK THE BORE OF THE NOZZLE.** It is important to replace the nozzle after it has worn 1/32". Not only will the worn nozzle use more compressed air, but the abrasive will impact the part more aggressively and increase the potential for damaging the masking material. As the volume of air and abrasive increases, it will create additional wear on the blast hose. Always depressurize the pressure pot during any machine maintenance.
- ❖ **A CLEAN DUST COLLECTOR WILL KEEP THE CABINET VISIBILITY AT ITS BEST.** Cleaning the dust collector is key to maintaining optimum cabinet visibility and abrasive separator efficiency. Use the pneumatic vibrator air ball valve, to turn on the air vibrator with the **BLOWER OFF**. Empty the dust storage hopper on an established schedule based on machine usage time, or the end of each day used.
- ❖ **USE MBA REPLACEMENT COMPONENTS.** Replacement of worn components with non MBA parts will void the machine warranty. The components used by Media Blast are of the highest quality and will provide the longest serviceable life.
- ❖ **REVIEW THE TROUBLESHOOTING GUIDE AND FOLLOW THE INSTRUCTIONS PRIOR TO CALLING MBA FOR TROUBLESHOOTING ASSISTANCE.** Most problems associated with the machine can be identified by simply consulting the Troubleshooting Guide. However, if your problem cannot be found in the Troubleshooting Guide, please give us a call. Nearly all equipment malfunction issues can be resolved over the telephone. Many times, it does not require the purchase of new components!
- ❖ **WITH THE PRO STAGE II IT IS VERY IMPORTANT TO NEVER OPERATE THE MACHINE WITH THE FOLLOWING:**
 1. Abrasive pot loading over 30 pounds..
 2. Operator not using hand protection gloves..

GETTING STARTED

UNIT PLACEMENT: Allow adequate clearance for loading and unloading the blast cabinet. MBA recommends 36" in front of the cabinet for the operator and 36" on the door sides of the cabinet. The Pro model Stage II includes one right side access door and one left side mounted dust collector service access door. Never place the unit where direct light can strike the operator view window. This will cause reflections on the view window and make it uncomfortable and difficult for the operator to view the work in progress.

INSTALLATION OF FOOT PEDAL VALVE: The Pro Stage II come with the foot treadle pedal packed inside the cabinet. The hoses are marked for assembly but the foot valve is a normally open passing air through valve holding the air inside the pot. Using push in tubing connectors, insert one tube into the line pressure fitting just after the Main Air Inlet and the other tube into the Micro Filter, # H Pneumatic Reference Diagram. Push the tube into the fitting until it bottom out, about 1/4".

ELECTRICAL REQUIREMENTS AND CONNECTION: All CrystalBlast sandcarving cabinets are wired standard for 120V / single phase service. MBA recommends that this cabinet be installed on a **dedicated 20-amp breaker** similar to any large single power-consuming appliance in your home. **Do not use extension cords** and if using, make sure the cord rating is rated for operation of the unit and no longer than 15'. This was covered on page 2 of this manual.

125 MAXIMUM INLET PRESSURE

AIR REQUIREMENTS AND CONNECTION: The standard 3/32" i.d. nozzle requires 5.7 cfm @ 30 psi. **Note: cfm – volume of compressed air in cubic feet per minute, psi – pressure of air in pounds per square inch.** Stopping the blast during machine operation to inspect the part and rotate and move the part will save on compressed air (e.g., blasting 50 seconds of every minute will decrease the compressed air requirements by 16%. Make sure that your air compressor exceeds this requirement by at least 75% (9-10 cfm for the 3/32" nozzle is highly advised. Premature compressor failure can be a secondary result of using a marginally sized air compressor. **Note: The supplied air inlet pressure must be at least 10 psi more pressure than the actual blasting pressure to close the pinch valve.** MBA recommends a two-stage air compressor but any air compressor capable of maintaining 9-10 cfm at 90-100 psi will be adequate for proper machine operation using the 3/32" nozzle. When **using a two stage air compressor storing more compressed air, set the maximum line inlet pressure at no more than 125 psi. This may require installation of a master compressor air regulator, if unclear call factory for more information.**

It is very important that the compressed air be clean and dry. Wet compressed air will cause the abrasive to bond together and stop flowing, also static and moisture can make the problem worse. Under sizing the air compressor, will create a situation that will not allow adequate time for the compressed air to cool in the air receiver tank. This warm compressed air enters the blast cabinet and immediately cools as the pressure drops. The resulting condensation will cause the abrasive to stick together. If wet compressed air is suspected, install an air dryer prior to the air entering the blast cabinet (MBA Ambient Air Dryer, P/N 100-03-173). **Note: As the blast nozzle wears, the air requirements for the system will increase. If the air compressor is not capable of handling the higher air volumes, the blast pressure will begin to decrease and loss of line pressure, will lead to poor machine performance and may result in erratic machine control operation. You can feel the air hose entering the cabinet, if the hose feels warm, it is over 98.6 F and will cause you problems when blasting long term.**

The minimum air hose size must be at least **3/8" ID**. Connect main air supply to the machine, (**Item B** - Pneumatics Reference Diagram), using quick disconnect sleeve couplers. The Pro model includes a Main Air Inlet Valve to control air On/Off. This valve is used to operate and control air to the machine to include pot loading.

SELECTING THE RIGHT ABRASIVE: There are three different basic types of abrasives that can be effectively used for etching and carving on glass; brown aluminum oxide, white aluminum oxide and black silicon carbide. Each type has beneficial qualities:

- ▶ **Brown Aluminum Oxide** – Some manufacturers recommend and sell this abrasive. This abrasive is more forgiving than silicon carbide because it is not as aggressive. It normally has more dust than silicon carbide and it cuts glass slower than silicon carbide. For industrial applications, it is the most commonly used abrasive for surface preparation for coatings. However, the productivity of aluminum oxide is significantly slower than silicon carbide and as the abrasive is used, the abrasive particles become more rounded which continues to reduce the effectiveness of the etch. Aluminum oxide is a good abrasive to use when sandcarving for the first time.

- ▶ **White Aluminum Oxide** - White aluminum oxide differs from brown aluminum oxide because it has no iron content. This means that the abrasive will not leave a stain on the part that is blasted. Since the abrasive is screened to tighter specifications, it may be less dusty than brown aluminum oxide. Both white and brown aluminum oxides are more forgiving on the mask material. MBA recommends that aluminum oxide be used by beginners and less experienced operators.
- ▶ **Silicon Carbide** - This abrasive is not recommended for beginning Sandcarvers. Silicon carbide is very aggressive and sharper than aluminum oxide and recommended for skilled Sandcarvers. The aggressiveness can be beneficial; carving and etching can be accomplished much faster with the silicon carbide. In addition, the silicon carbide never loses its sharp edge. Silicon Carbide will create a far better part detail and process the part faster.

Qualities and recommendations aside, the choice for blasting abrasive is personal one. Some people will prefer the white aluminum oxide, while others will prefer the brown aluminum oxide or the silicon carbide. Some prefer the least expensive and some simply want the fastest processing. The typical size ranges used are 150 and 180 mesh. The finer sizes provide a smoother finish on the blasted surfaces with more detail. **Note: The use of silica sand, garnet, slag, Starblast™ or other non-recyclable abrasives in the system will void the CrystalBlast® Pro line equipment warranty. Sand contains free silica known to be a Health Hazard.**

LOADING THE SYSTEM WITH ABRASIVE: Turn on the power to the machine (**Item 1** – Operation & Maintenance Diagram). The abrasive of choice should be loaded through the cabinet door with the dust collector blower running. The Pro Stage II model requires an initial charge of 30 pounds of abrasive, 180 mesh or larger. **This is very important when using 220 mesh, only the Pro Stage III Elite is advised for operation using 220 mesh using its Patented 150 to 220 Separator Reclaimer. Note: Never add abrasive to the system unless the dust collector blower is running, this will lesson and control fine dust contained in new abrasive.**

There is no need to pre-screen the abrasive. The CrystalBlast Pro system includes a perforated scalper screen designed to remove all particles large enough to clog the nozzle. Additional abrasive should be added from time to time to maintain maximum levels in the system but it is best to operate the machine until the speed of processing has greatly decreased. This is caused by smaller and smaller abrasive wearing to a finer size taking longer to process a part... Shorter blast intervals between pot reload is a good indication that more abrasive needs to be added to the system or simply replaced like oil in your car. (EXAMPLE: The 3/32" blast nozzle consumes approximately 1.1 pounds per minute of abrasive for approximate total blast duration of 25 to 30. minutes with a full abrasive charge in the blast pot and a new nozzle ID size. If the total blast time to empty the pot falls to 15 minutes, and the nozzle is still a true 3/32", add 10 pounds of abrasive to the system to bring the system up to a full charge.) **Note: This information assumes the nozzle size is 3/32" and not worn out.**

FILLING THE BLAST POT: Loading the system with abrasive will also fill the blast pot as long as the pot has been depressurized... With the pot de-pressurized the Pot Valve will be open, (#24 Maintenance Diagram) allowing the abrasive to drain through the perforated screen into the pot assembly. This is accomplished with the main air inlet valve closed, (#17 Operation and Maintenance Diagram). Always do this operation with the blower and dust collector running. To make sure the pot is depressurized, press down on the blast pedal until all air has exited the pot. Next quickly open the main air inlet valve, (**Item 17** – Operation & Maintenance Diagram), located on the right side of the regulator cluster. This will close and seal the Pot Valve to the rubber seal seat and close the pinch valve operated by the blast pedal at the same time. **Note: The air compressor receiver tank must have a pressure of 90-100 psi prior to pressurizing the blast pot.**

ADJUSTING THE BLAST PRESSURE: The blast pressure is adjusted from the pressure regulator and gauge, (**Item C and D**) – Pneumatics Reference Diagram), located at the front of the operator station, you can unlock and relock the regulator by pulling up and pushing down on the regulator knob. Rotating the pressure regulator adjustment knob clockwise will increase the blast pressure. Rotating the pressure regulator adjustment knob counter-clockwise will reduce the blast pressure. Typical blast pressures for etching and carving on glass is 20 – 40 psi with 30 psi suggested. **Note: This machine should not be operated at pressures greater than 60 psi.**

ADJUSTING THE ABRASIVE FLOW: The abrasive flow is adjusted using the Abrasive Choke Valve **Item F** – Pneumatics Reference Diagram. The Abrasive Choke Valve is located on the bottom right side of the pressure pot, (**F of the Pneumatic Reference Diagram**). When the Abrasive Choke Valve is completely open, **parallel to the hose**, you will see very little abrasive exiting the nozzle. **Adjust as follows but, never, never, never close the Abrasive Choke Valve completely:**

First set the Abrasive Choke Valve at 45 degrees and test the blast pattern by pressing down and holding the Foot Pedal Valve. If very little abrasive is exiting the nozzle after 2-3 seconds, close the Abrasive Choke Valve a small amount by moving the handle about 1/4" towards the closed position. Just before the nozzle is delivering the proper amount of abrasive, the abrasive flow will pulse slightly. Close the Abrasive Choke Valve a bit more and the pulsing will disappear, the setting is now correct. This setting will stay correct unless you change the blasting pressure or the abrasive wears to a smaller mesh size. **You may adjust the Choke Valve at any time to maintain proper flow delivery of the abrasive.**

Always shut off the Main Air Inlet Valve first to de-pressurize the pressure pot and also press down on the blast pedal valve at the end of daily operation or when the air compressor will be turned off. Depressurize the pot assembly when the air compressor is going to be turned off for the day by closing the Main Air Inlet Valve and using the blast foot valve to exhaust all the air from the pot. Remember to have the machine blower running to prevent abrasive escape.

WEARING GLOVES: The CrystalBlast Pro Stage II Model includes a box of 100 disposable gloves. **The Stage II Pro uses a much higher cfm blower than the Stage I and operates using high velocity work ports. Always use gloves to protect hands and never wear any jewelry during machine operation.** Abrasive can cause irritation or damage to the skin if accidentally exposed to the blast. **MBA say always wear glove protection while blasting.** All CrystalBlast Pro models are available with attached gloves upon customer request.

READY TO BLAST: The unit is now ready for blasting. Turn on the electrical on-off switch (**Item #1**– Operation & Maintenance Diagram). Place a piece of scrap glass inside the cabinet and close the side access door. Using glove protection, place both hands in the velocity ports and pick up the scrap piece of glass for the test. Hold the nozzle/nozzle holder like a pencil pointing your index finger at the part surface and holding the tip of the nozzle about 3-4 inches from the part surface. Keep the nozzle perpendicular to the part surface to prevent lifting of the film mask. Press down and hold down the blast pedal. This starts the blast, always remember to start the blasting off of the part surface. **Note: Never point the nozzle at the window. The abrasive will permanently frost the protector window. Move the nozzle in slow even passes; do not wiggle the nozzle in rapid motions. Think Candle and Flame moving the nozzle slow enough to create frictional heat and fast enough to not burn the film.**

Note: The MBA CrystalBlast Pro system will provide different results than other blast systems. When the unit is first operated, use scrap glass to become familiar with the nozzle pattern and speed. Place masking material on the scrap glass to test and see how long the mask material will stand up to the blast. The experienced operator may find that the CrystalBlast Pro system will be operated at lower blast pressures than previously experienced with other systems due to the extreme focused blast pattern allowing deeper carving without film damage.

FINISHING BLAST: At the end of the day, when the blasting is finished or when the air compressor is turned off, the blast pot must be depressurized. Close the Main Air Inlet Valve, (**Item B** Pneumatics Reference Diagram) and use the blast pedal, (**Item I**) Pneumatic Diagram). **Make sure the dust collector blower is running.**

PRESSURE BLAST CFM CONSUMPTION										
Nozzle Size		CFM CONSUMPTION AT SPECIFIC PRESSURES								
		20 PSI	30 PSI	40 PSI	50 PSI	60 PSI	70 PSI	80 PSI	90 PSI	100 PSI
1/16"	0.062	2.00	2.50	3.10	3.70	4.20	4.80	5.40	5.90	6.50
3/32"	0.094	4.40	5.70	7.00	8.20	9.50	10.80	12.10	13.30	14.60
1/8" (#2)	0.125	7.90	8.38	10.29	12.20	14.02	15.93	17.76	19.67	21.80
3/16" (#3)	0.187	15.00	18.92	23.24	27.39	31.54	35.85	40.08	44.15	49.00
1/4" (#4)	0.250	26.00	33.62	41.17	48.64	56.11	63.66	71.13	78.68	85.00
5/16" (#5)	0.312	42.00	54.61	67.06	79.10	91.13	103.63	115.66	127.74	140.00
3/8" (#6)	0.375	58.00	75.61	92.96	109.56	126.16	143.59	160.19	176.79	194.00
7/16" (#7)	0.437	83.00	105.03	128.65	152.31	175.55	199.20	222.44	245.68	268.00
1/2" (#8)	0.500	105.00	143.46	164.34	195.05	224.93	254.81	284.69	314.57	346.00

ABRASIVE DELIVERY, POUNDS PER MINUTE			
Nozzle Size		POUNDS PER MINUTE DELIVERY. New Nozzle. Proper Flow Set	
		30 PSI	40 PSI
1/16"	0.062	0.5 Pounds Per Minute	
3/32"	0.094	1.1 Pounds Per Minute	
1/8"	0.125	2.0 Pounds Per Minute	

MAINTENANCE:

GENERAL EQUIPMENT MAINTENANCE (Intervals May Vary Depending on Equipment Usage)	DAILY	Weekly	MONTHLY	SEMI-ANNUALLY	ANNUALLY
	DRAIN REGULATOR WATER TRAP	X			
CLEAN CARTRIDGE FILTER	Every 2 Hours				
CLEAN THE ABRASIVE SCALPER SCREEN		X			
REMOVE DUST FROM DUST COLLECTOR	X				
INSPECT THE BLAST NOZZLE		X			
INSPECT THE BLAST HOSE			X		
CLEAN AIR INLET FILTER		X			
REPLACE FILTER CARTRIDGE					X
REPLACE ALL ABRASIVE, PURGE	DDC, Daily Duty Cycle Determines				

CLEANING THE ABRASIVE SCALPER SCREEN: Lift up the perforated metal work grate and remove the grate from the cabinet. Use a shop vacuum to clean the debris off the scalper screen. Replace the operator work grate.

CLEANING THE DUST COLLECTOR FILTER: The dust collector filters should be cleaned daily, or every two hours of machine use. A clean filter means a clean machine and a clean work area. This operation is critical to the operation of any blasting cabinet. Turn OFF the blower using the Blower Switch, **#1 OMD Diagram**, and open the air ball valve located on the air regulator cluster, **Item E PRD Diagram**. This will start the vibrator and release collected dust dropping the dust into the dust storage hopper. Operate the vibrator for 2 to 3 minutes. When first operating the machine, turn off the blower and look at the dust collector filter. You want to see pleats but remember this is a dirt collecting filter not to be confused with a new clean filter. **If you exceed the machine DDC, Daily Duty Cycle, and don't increase the cleaning cycles it is possible to pack the filter with dust.**

REMOVING THE DUST FROM THE DUST COLLECTOR: MBA recommends daily dust removal from the dust storage hopper and a pneumatic cleaning cycle at the beginning of each day after the dust collector has been inactive. This is the best time to clean any dry dust collector used with any blasting cabinet.

Next unscrew the dust collector hopper drain cap (**Item 8 – Operation and Maintenance Diagram**), but do not remove. With one hand, hold the neck of a plastic bag on the pipe nipple above the hopper drain cap (or use a garbage bag with tie straps and tie it to the pipe nipple). With the other hand, grasp the drain cap through one corner of the bottom of the plastic bag. Finish unscrewing the drain cap and move it aside to allow the dust to drain into the bag. Continue to hold the cap through the plastic bag or drop and retrieve after draining. Screw the drain cap back on the nipple. Grasp the neck of the plastic bag below the drain cap and remove the bag. The dust should be contained completely in the bag for

disposal without exposing the surrounding area or the operator to the dust. You can turn on the cleaning vibrator to remove the dust from the hopper faster, cleaning the filter cartridge at the same time.

INSPECTING AND REPLACING THE BLAST NOZZLE: It is important to replace the nozzle after it has worn 1/32". Not only will the worn nozzle use more compressed air, but the abrasive will impact the part more aggressively. As the volume of air and abrasive increases, it will create additional wear on the blast hose too. The easiest way to know if your nozzle requires replacement is to keep a 1/8" drill bit nearby. If the drill bit fits into the blast nozzle, then it is time to replace the nozzle. **Replacement is not mandatory but, a worn nozzle uses more compressed air and if the air compressor is marginal, the machine controls will not operate properly unless 90 psi line pressure is maintained at all times.**

Always depressurize the pressure pot during any machine maintenance; To replace the blast nozzle, hold the nozzle and nozzle holder (**Item K** – Pneumatics Reference Diagram) in your right hand and the blast hose (**Item J** – Pneumatics Reference Diagram) in your left hand. First use any plastic screw driver handle to tap the nozzle holder to release any abrasive locking the release ring. With your right thumb and forefinger, press the end ring of the nozzle holder toward the hose, (see diagram below). As you are pressing, pull the abrasive blast hose the other direction using a twisting motion. The hose should release from the nozzle holder. **Note: Do not try to remove the nozzle from the nozzle holder.** The nozzle holder is designed to be an integral part of the nozzle for safety. Removal and reinstallation of the nozzle in the nozzle holder may cause the nozzle to become a projectile. Injury may occur as a result. Dispose of the old nozzle and holder properly as a single unit when the nozzle has worn out.

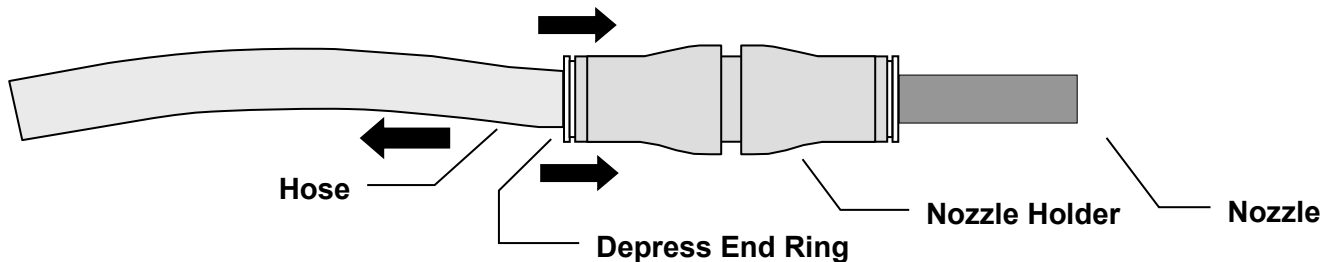

REPLACING THE BLAST HOSE: Always depressurize the pressure pot during any machine maintenance; To replace the blast hose, hold the nozzle and nozzle holder in your right hand and the blast hose in your left hand. With your right thumb and forefinger, press the end ring of the nozzle holder toward the nozzle (see diagram). As you are pressing, pull the abrasive blast hose the opposite direction. Remove the other end of the hose from the connector using the same process. **Note: All hoses and tubing are removed using this same procedure.** Replace with new abrasive hose in reverse of above procedure.

REPLACING THE LED LIGHT: **Always observe all OSHA Codes for Machine Service and Maintenance regarding Electrical and Air Lock-Outs and Lock-Out Tags making sure the electrical supply is removed.** Replace the LED light by removing all power and air from the machine. Make sure to depressurize the pot when performing any machine maintenance. You must remove the light housing to access the LED light. This light includes a sealed glass and mounting Z Brackets you must also remove. A wiring partition exists in the light housing allowing you access to the light wires. Remove the light wires and replace with the new light assembling in reverse. Test the light at this time before you assemble.

REPLACING THE WINDOW PROTECTOR OR VIEW WINDOW: Remove the screws located on the top window bracket first. Next loosen the bottom screws but do not remove the screws from the cabinet. The bottom bracket will hold the window and window protector during replacement of the protector window. Remove the operator view window, clean and set aside. Next remove the window protector glass. Replace with a clean the new protector glass then replace both parts as a sandwich into the bottom holding bracket. Install the top window bracket and hand tighten the fasteners. Tighten the bottom bracket and top bracket in stages. Make sure not to over-tighten the fasteners always tightening the bottom bracket before the top bracket.

REPLACING THE DUST COLLECTOR CARTRIDGE FILTER: **Prior to replacing the cartridge filter clean the filter using the vibrator cleaning cycle.** This will lighten the filter cartridge making replacement simple. Turn off the power to the machine. Remove the dust from the dust collector hopper first. (Please refer to the REMOVING THE DUST FROM THE DUST COLLECTOR)

Once the dust has been removed and the cap placed back on the hopper. Tap on the dust collector door near the bottom of the door to release any ledge dust. Open the access door to expose the filter cartridge.

1. You will see the vibrator bracket, the spacer, with holding pins, tightening knobs and nylon jam lock nut on each of two threaded rods.
2. Lower the two nylon jam nuts about 3 full revolutions, replace these after replacement of the filter twice.
3. Lower the hand tightening knobs to loosen the spacers, know that the new filter will have a un-compressed top seal and require a bit more room for the spacers.
4. Remove the C-Clips on each space and set aside. Remove the two removable spacers while holding the dust collector vibrator bracket with one hand making sure the filter does not drop down.
5. Lower the vibrator bracket with the filter cartridge to the bottom of the two outside rods. This allows removal of the filter with the open door.
6. Remove and replace the cartridge bottom sealing washer located on the vibrator bracket. Makes sure this step is not missed or the filter will leak.
7. Insert the new filter making sure to locate the top centering ring in the 8" top filter cartridge opening.
8. Push up on the vibrator bracket making sure the center sealing pin is located in the bottom cartridge centering hole.
9. Place the two spacers on the rods between the knobs and vibrator mounting plate and hold in place by installing the C-Clips.
10. Hand tighten the two knobs making sure the filter is centered, tighten the filter enough, testing to make sure at the top of the filter cartridge.
11. Use the Jam nuts to keep the tightening knobs from unscrewing. If you do not replace the nylon nut, drill two small holes in the tightening knobs. When tight, tie the two close knob handles using wire; this will prevent them from turning.
12. Move the two jam nuts to the bottom of the tightening knobs and lock together.
13. Check again for top seal tightness...



UNDERSTANDING FILTER CARTRIDGE CONDITION

Use the following photos to see if you are operating the dust collector cleaning cycle properly or enough cleaning cycles per day for your application. Not all applications are the same and or require the same number of daily cleaning cycles.



The photo at the left shows the condition of a new filter cartridge. This is not how they will ever appear again until new filters are installed.

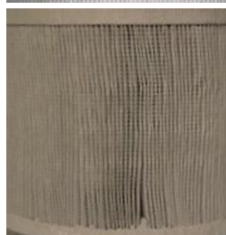

This is a photo of a typical seasoned and just cleaned filter. The color is the cartridge showing the dirt being removed; the cartridge is about 1 year old.



This photo shows a filter cartridge that should be cleaned. Keeping the pleats visible is key to moving air from the cabinet. Moving air means cabinet visibility and pleats still showing means air is being moved.

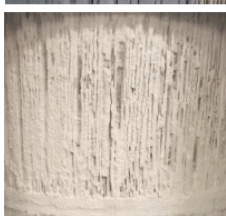

This photo shows a plugged filter cartridge. It can be caused by wet air or simply not operating the vibrator cleaning cycle properly or enough time for 8 hour days.

REPLACEMENT OF THE PNEUMATIC PINCH VALVE BLADDER:

1. Turn Off Machine Air & depressurize pot assembly.
2. It is advisable to drain existing abrasive from the blast pot prior to Pneumatic Pinch Valve removal and or service. Remove all abrasive using the pressure pot access port described in the machine maintenance manual, "Changing Abrasive".
3. Locate the Pneumatic Pinch Valve attached to the bottom of the pressure pot assembly. Removing the Pneumatic Pinch Valve from the machine is recommended for maintenance.
4. With a ½" wrench or socket, remove the 8 bolts holding the two end caps to the valve body. Remove both end caps.
5. **Removing the Core, Part #109-20-302**
With end caps removed, remove damaged core and set aside.

Replacing Bladder Part #109-20-301

With core removed, use any flat screwdriver to carefully pry the damaged bladder from the valve body. Take care to not damage the valve body. Replace with the new bladder making sure the bladder is seated. Inspect core and replace with new core if old core appears worn. Install core in the center of the new bladder.

6. Replace End caps with the ½" bolts and lock washers making sure the contours of the end cap line up with the contours of the body.
7. Re-install the Pneumatic Pinch Valve on the machine and make sure no abrasive grains exist on the valve or pot nipple assembly.
8. Replace pressure pot access port, make sure the pot seal is located properly. You may now charge the machine with abrasive.
9. Turn the machine air back on.



109-20-302



109-20-301

DRAINING THE BLAST POT AND REPLACING WITH NEW ABRASIVE: In general, as the abrasive breaks down, the dust will be carried to the dust collector. Small particles of abrasive will remain in the recyclable abrasive mix until it is too fine to be retained by the abrasive reclaim separator. This may or may not cause a noticeable difference in the blast productivity or etch finish. Oftentimes, it will not be noticeable because additional abrasive is added from time to time to make up for the abrasive that has been broken down. If a noticeable difference in the blast productivity or etch finish occurs, the abrasive may need to be replaced in the system. MBA recommends the following procedure for change-out of the abrasive:

1. **Turn Off Machine Air & depressurize pot assembly.**
2. Make sure that the lights and exhaust blower are running on the machine.
3. Depressurize the blast pot by closing the Main Air Inlet Valve and draining the pressure pot using the blast pedal.
4. You will hear a metallic clunk when the pot valve opens.
5. Place a pan underneath the blast pot, a cement mixing trough works well and hold the abrasive.
6. Loosen and remove the access port crab bracket nut.
7. Remove the Crab bracket.
8. Install the nut back on the Crab nut and hit with a rubber hammer or wooden block, this will loosen the port cover.
9. Push the port into the pot and spin to remove the port stud last. This is the only way to remove the port cover.
10. Set the port cover gasket to the side.
11. Remove the front located drain on Air/Abrasive Mixing Tee fitting (**Item G** – Pneumatics Reference Diagram) at the bottom of the blast pot. This drain is for the removal of nested material in the pot. It is not the way the pot should be drained.
12. Remove the perforated metal work grates from the cabinet.

13. Using a wide putty knife, move all the abrasive from the hopper corners and the ledges to the perforated scalper screen, the abrasive will drain into the blast pot. **Note: To ensure that no residual abrasive is left in the blast pot, the blast pot can be tapped with a rubber mallet to dislodge any trapped abrasive. To ensure nearly complete evacuation of abrasive, remove the pot cleanout port on the rear of the blast pot and use a shop vacuum to clean any residual abrasive out of the blast pot.**
14. At this time remove the abrasive from inside the pot, using gloves to scoop out the abrasive into the cement bin under the open pot access port.
15. Remove as much as possible then use a shop vacuum to remove the remaining abrasive. Make sure to vacuum the very bottom of the pot with the drain plug remove. This will remove any nested material causing abrasive flow problems.
16. Replace and tighten the plug in the Air/Abrasive Mixing Cross fitting making sure no abrasive is in the plug or the threads. When installing use only Teflon tape.
17. Use contact spray glue to attach the pot cover seal to the pot cover. Install the cover in reverse of the extraction.
18. While holding the cover in place using the port cover stud, install the port cover crab bracket and nut, then tighten. Remember this cover is under pressure and does not need to be really tight, only sealed.
19. Replace the expanded metal work grate.
20. **Note: It is critical to remove all the abrasive from the pressure pot assembly. Remove the access service cover on the side of the blast pot. To do this, remove the nut that holds the crab bracket in place. Once the nut and crab have been removed, the blast pot access cover can be manipulated out of the blast pot by turning 180 degrees. Use a shop vacuum to clean the rest of the abrasive out of the blast pot. When replacing the blast pot access cover, make sure that the rubber gasket and access cover are uniformly aligned across the access hole.**
21. Add 30 pounds of new abrasive to the system making sure the plug at the bottom of the pot mixing Tee has been replaced.

REPLACING THE POT SEAL OR THE POT VALVE PLUNGER: This maintenance procedure will unlikely need to be performed for many years however, eventually the blast pot seal will wear out requiring replacement.

1. Turn the machine on.
2. Turn off the Main Air Inlet Valve and depressurize the blast pot using the Foot Pedal Valve.
3. Place a pan under the blast pot to catch any abrasive that comes out of the blast pot.
4. Remove the pot service port; see above for how to remove.
5. With the port service port removed, and some of the abrasives removed, you can remove the pot valve
6. Unthread the pipe riser inside the pot that guides the Pot Plunger up and down, do not over tighten this nipple when replacing.
7. Remove the pipe riser and Pot Plunger at the same time together.
8. Locate the donut shaped pot seal on the abrasive inlet to the blast pot. You will see a metal seal inside a U shaped metal seal holder.
9. Use a small seal pick, Google for example, between the metal lip of the blast pot and the blast pot seal. Pry the blast pot seal out of the blast pot, note location of the seal bevel, **INSIDE AT THE BOTTOM.**
10. Clean out the seal U-Channel and install the new seal bevel down. After getting the seal into the U-Channel, use something like a 1" round wood dowel to put pressure against the new seal while moving the dowel in a rapid circular motion. This will seat the seal in position making sure there are no high spots.
11. After installing, make sure the bevel is located at the bottom where the pot valve head can touch the beveled seal first and no seal high spots are felt when running the dowel in a circle.
12. Replace the Pot Plunger and pipe riser together as a single assembly. The parts must be assembled together before putting inside the blast pot and the pipe riser threaded into place.
13. Reinstall the access cover on the rear of the blast pot; see procedure above "Draining the Blast Pot". When replacing the blast pot access cover, make sure that the rubber gasket and access cover are uniformly aligned across the access hole. Install the Crab Bracket and install the Tightening Nut that holds the access cover in place.
14. Check the pot valve by sliding it up and against the new pot seal.
15. Re-pressurize and depressurize the blast pot several times. Be sure to pull slightly on the handle each time the pot is pressurized and push the handle to drop the Pot Plunger each time the pot is depressurized.
16. Reinstall the expanded metal work grate.

TROUBLESHOOTING:



WILL NOT BLAST: COMPRESSED AIR (BUT NO ABRASIVE OR “V” SPLIT PATTERN)

WILL NOT BLAST: NO COMPRESSED AIR OR ABRASIVE

“V” BLAST PATTERN FROM NOZZLE

BLAST NOZZLE IS PLUGGED: *Remove the nozzle/nozzle holder from the blast hose. Use a small, stiff wire to dislodge the obstruction.*

BLAST POT IS EMPTY: *Depressurize the blast pot using the Main Air Inlet Valve and Pot Plunger Assembly Handle, see procedure*

NO ABRASIVE IN THE CABINET: *Add 30 pounds of abrasive to the system. Be sure that the dust collector is on when the cabinet is loaded with abrasive.*

ABRASIVE CHOKE VALVE IS NOT ADJUSTED CORRECTLY: *Rotate Abrasive Choke Valve arm to approximately 45° and test for abrasive flow. Refer to the “Adjusting the Abrasive Flow” section of the manual for adjustment procedures if the flow is not quite correct.*

ABRASIVE IS DAMP: *Wet abrasive sticks together. Clean the abrasive out of the machine and replace with fresh abrasive. Determine cause of moisture and repair problem to prevent reoccurrence. Check the filter trap on the air regulator; drain if there is water in it. Install MBA Inline Ambient Air Dryer (P/N 100-03-173) to prevent reoccurrence.*

ABRASIVE IS NOT INSIDE THE POT: *Depressurize the pot to allow the abrasive to drop.*

CHECK REGULATOR: *Is it turned off?*

COMPRESSED AIR IS TURNED OFF OR DISCONNECTED FROM BLAST CABINET: *Make certain that the compressed air is connected to the blast cabinet and turned on.*

BLAST POT IS DEPRESSURIZED: *Pressurize blast pot by rotating the Main Air Inlet Valve handle (Located on the right side of the air regulator) to the horizontal position.*

BLAST NOZZLE IS PLUGGED: *Remove nozzle and use a small, stiff wire to dislodge the obstruction.*

ABRASIVE CHOKE VALVE COMPLETELY CLOSED: *If the Abrasive Choke Valve is completely closed (Abrasive Choke Valve arm in the vertical position), then the abrasive hose is probably plugged with abrasive. Refer to abrasive hose unplugging procedure in the “Adjusting the Abrasive Flow” section*

SMALL PIECE OF DEBRIS LODGED IN NOZZLE: *Remove the nozzle/nozzle holder from the blast hose. Use a small, stiff wire to dislodge the obstruction.*

BLAST WILL NOT STOP

PNEUMATIC PINCH VALVE SLEEVE HAS A HOLE: *Immediately decompress the blast pot. Turn off main supply of air to the blast cabinet. Refer to the “Replacement of the Pneumatic Pinch Valve Sleeve” section in the manual for repair procedure.*

BLAST NOZZLE IS WORN OUT: *Air compressor cannot keep up with the air volume necessary to operate the larger blast orifice, so the compressor line pressure drops below 80 psi. Immediately decompress the blast pot. Replace nozzle.*

DEBRIS IN THE PNEUMATIC PINCH VALVE: *Immediately decompress the blast pot. Remove the Pneumatic Pinch Valve from the machine. Remove both hex nut covers. Clean out the valve. Inspect the sleeve for holes. Reassemble and reinstall.*

BLAST POT WAS NOT DEPRESSURIZED AND COMPRESSOR WAS TURNED OFF: *Depressurize blast pot.*

AIR COMPRESSOR DOES NOT CYCLE ON UNTIL PRESSURE DROPS BELOW 80 PSI: *Replace air compressor or change control on compressor.*

AIR COMPRESSOR IS TOO SMALL: *Air compressor does not generate enough volume of air to maintain a line pressure of 80 psi or more.*

ERRATIC ABRASIVE DELIVERY FROM NOZZLE

NOZZLE IS WORN OUT: *Replace nozzle.*

ABRASIVE FLOW VALVE IS NOT ADJUSTED CORRECTLY: *Erratic abrasive delivery is usually caused by too rich abrasive flow. Rotate Abrasive Choke Valve arm in small increments towards a horizontal position. Refer to the “Adjusting the Abrasive Flow” section of the manual for adjustment procedures if the flow is not quite correct.*

ABRASIVE IS DAMP: *Wet abrasive sticks together. Clean the abrasive out of the machine and replace with fresh abrasive. Determine cause of moisture and repair problem to prevent reoccurrence. Install MBA Inline Ambient Air Dryer (P/N 100-03-173) to prevent reoccurrence.*

ABRASIVE IS WORN OUT: *Replace the abrasive. Refer to the “Draining the Blast Pot and Replacing with New Abrasive” section of the manual for procedures in replacing the abrasive.*

LARGE SURGE OF ABRASIVE AT THE BEGINNING OF THE BLAST

ABRASIVE FLOW ASSEMBLY IS WORN OUT: *Replace the Air/Abrasive Mixing Cross located beneath the blast pot.*

**AIR LEAK HEARD AFTER
REFILLING THE BLAST POT WITH
ABRASIVE**

**POT PLUNGER DID NOT SEAT PROPERLY WHEN
BLAST POT WAS PRESSURIZED:** *Depressurize
blast pot, push in and pull back on the Pot Plunger
Assembly Handle with a slight pressure and
simultaneously pressurize the blast pot by opening the
Main Air Inlet Valve.*
POT SEAL IS WORN OUT: *Refer to “Replacing the
Pot Seal or Pot Plunger” section of the manual.*

BLAST POT WILL NOT SEAL

COMPRESSED AIR IS TURNED OFF: *Make certain
that the compressed air to the blast cabinet is turned
on.*

POT SEAL IS WORN OUT: *Refer to “Replacing the
Pot Seal or Pot Plunger” section of the manual.*

BLAST REGULATOR IS SET TOO LOW: *Increase
pressure 10 psi; try again.*

TOO MUCH ABRASIVE IN SYSTEM: *Abrasive is
resting on the Pot Plunger, keeping it from getting a
good seal.*

**SYSTEM WON'T MAINTAIN
DESIRED BLAST PRESSURE**

NOZZLE IS WORN OUT: *Compressor is not large
enough to handle the additional air volume necessary
to run a larger bore nozzle. Replace blast nozzle.*

**OPERATOR IS GETTING SHOCKED
BY THE MACHINE**

PART IS BEING HELD IN OPERATOR'S HAND:
*Place part on the work surface while blasting or
purchase MBA's Static Electricity Discharge Cuff (P/N
100-22-021) to ground the operator to the blast
cabinet.*

**PART IS BEING PLACED ON A RUBBER MAT OR
OTHER NON-METALLIC SURFACE:** *Place part on
the work surface while blasting or purchase MBA's
Static Electricity Discharge Cuff (P/N 100-22-021) to
ground the operator to the blast cabinet.*

HUMIDITY IS LOW: *Purchase MBA's Static
Electricity Discharge Cuff (P/N 100-22-021) to ground
the operator to the blast cabinet.*

**ABRASIVE AND/OR DUST IS
COMING OUT OF THE EXHAUST
BLOWER**

FILTER CARTRIDGE IS LOOSE:

Check the filter for tightness

If the unit is equipped with filter cartridge make sure the cartridge tightening knob is tight. Open the access door and using a pair of gloves to hold the filter cartridge while gently push the filter side to side and check for movement. If the filter cartridge moves the tightening knob must be tightening to collapse the top seal.

Make sure no pleats have punctures, if you see a hole, fix the hole using a 100% silicon sealer. Vacuum the area and apply a liberal amount of silicone to the affected area making sure to spread open the pleats on both sides of the hole. Do not turn the blower on for 24 hours and the affected area will be fixed preventing dust escape in the future.

If you have been operating for unit very long with a damaged filter cartridge you may need to remove the cartridge and vacuum the inside area of the cartridge to stop the visual dust from exiting the blower housing. Replacing the filter may be required



CRYSTALBLAST Pro Stage I, II and III SYSTEMS DIAGRAMS AND PARTS LIST

TO FIND THE PART AND PART NUMBER FOR YOUR MACHINE:

1. Determine in which system the part is most likely to be found (hardware, pneumatic, dust collector, sheet metal or electrical).
2. Refer to the appropriate diagram.
3. Find the location of the part and note the corresponding bubble number.
4. Refer to the corresponding system section of the parts list and locate the corresponding bubble number.
5. If there are multiple listings for the bubble number, the correct part and part number can be determined from the bubble number descriptions.



CrystalBlast® PRO Stage- I, II & III

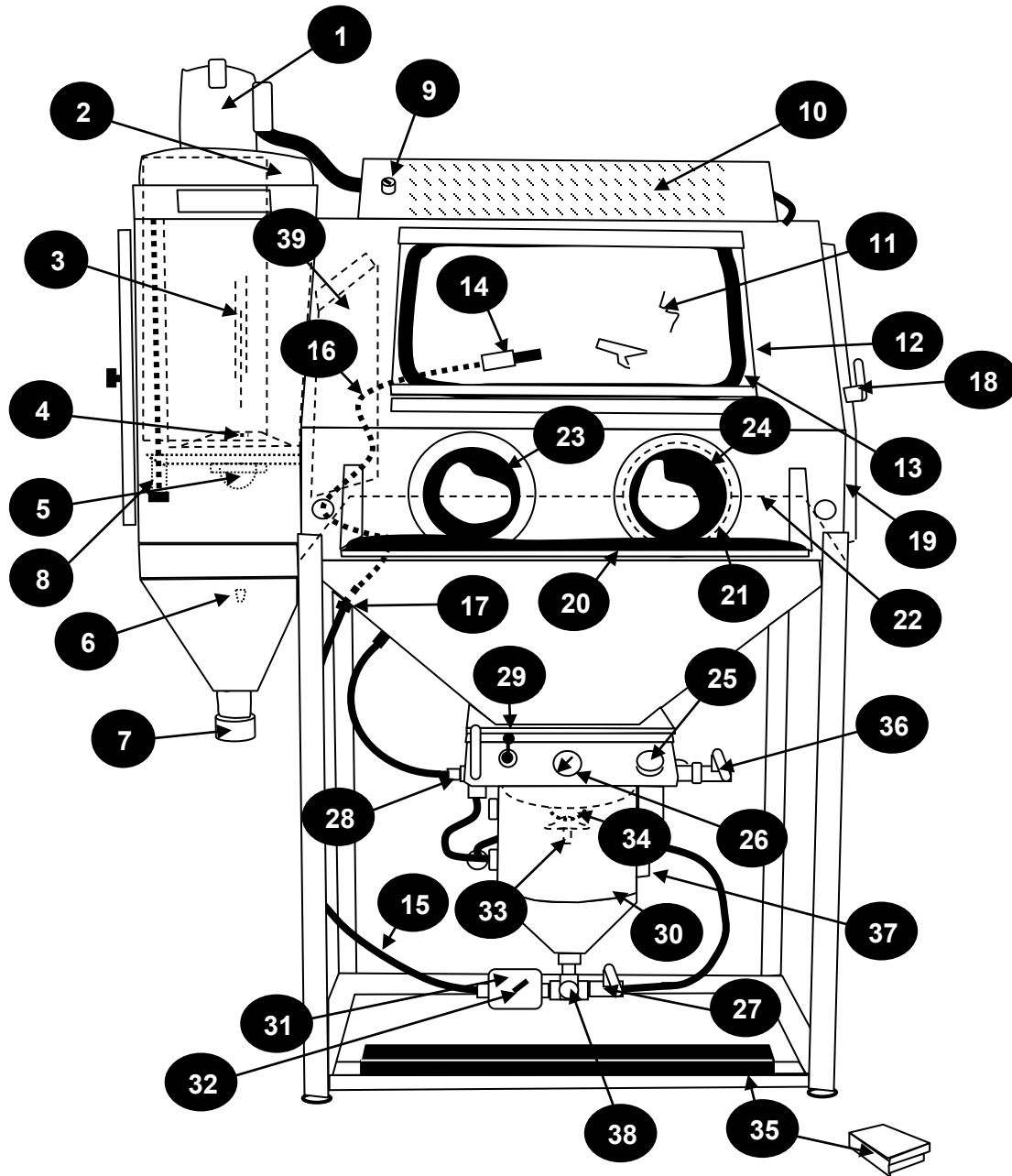

Locate the Part; see the Part Listing on the Following Page

Crystal Blast Pro Stage II

Bubble #	Part #	Description	Qt.
1.	100-05-101	1/2HP Blower Motor, 3450 RPM	1
1.	100-05-010	Vacuum Blower Motor, Stage I Only	1
2.	100-05-312	Blower Impeller, 10"	1
3.	100-08-005	Filter Cartridge 110 Sq. Ft.	1
4.	100-08-013	Cartridge Bottom Seal	1
5.	100-08-131	Cartridge Vibrator	1
6.	100-08-132	Spring Muffler, Adjustable	1
7.	100-08-142	Drain Cap	1
8.	100-08-141	Filter Retaining Knob	2
8.	100-08-138	Cartridge Mounting Rod	2
8.	100-08-012	Cartridge Rod Spacers	2
9.	100-09-610	On-Off Selector Switch Complete	1
10.	100-06-604	Air Inlet Filter	1
11.	109-06-029	Window, Safety Glass	1
12.	109-06-030	Window Protector Glass, 5 each minimum	1
13.	101-11-147	Window Seal, by the foot	6 Ft.
14.	109-19-093	3/32" Tungsten Nozzle with Holder for 1/2 hose	
14.	109-19-596	3/32" Boron Carbide Nozzle with Holder 1/2 hose	
14.	109-19-092	3/32" Tungsten Nozzle with Holder for 3/8 hose	1 standard
14.	109-19-594	3/32" Boron Nozzle with Holder for 3/8 hose	
15.	109-15-500	1/2" OD Micro Blast Hose, by the foot	10 Ft.
16.	109-15-375	3/8" OD Whip Hose by the foot	1
17.	109-20-101	3/8" to 1/2" Whip Hose Adaptor	1
18.	100-06-092	Door Handle, Elite	1
18.	100-06-091	Door Strike, Elite	1
18.	109-06-603	Door Handle Right Stage I & II	1
19.	100-11-030	Door Seal, Elite	1
19.	102-14-114	Door Seal, Stage I & II	1
20.	100-07-101	Armrest Pad only	1
21.	102-12-038	Gauntlet Clamp	2
22.	100-25-109	Work Grate, 2 Piece	1 Set
23.	109-12-105	Gauntlet (elastic cuff) Optional	1 Each
24.	109-12-100	Gauntlet standard, Stage I & II	2
24.	100-12-136	Attached Gloves, Stage I	1 Pair
25.	100-03-080	Air Regulator/Filter	1
26.	100-13-075	60 PSI Panel Pressure Ga, Stage III Elite	1
26.	100-13-077	60 PSI Pressure Gauge, Stage I & II	1
27.	100-26-098	Abrasive Choke Valve	1
28.	109-26-001	3-Way Valve, Stage III Elite	1
29.	100-20-112	Air Toggle Switch, Stage III Elite	1
30.	109-21-603	Pressure Pot, (50 pound capacity)	1
30.	109-20-200	Pinch Valve BIG BLUE, Stage I	1
30.	109-20-201	Pinch Valve Bladder, Stage I	1
32.	109-20-300	Pinch Valve, High Pressure, Stage II & III	1
32.	109-20-301	Pinch Valve Bladder, Stage II & III	1
32.	109-20-302	Pinch Valve Brass Core, Stage II & III	1
32.	109-20-105	Micro Inlet and Outlet Filter	1
33.	109-21-201	Pot Valve	1
34.	104-21-176	Pot Seal	1
35.	100-26-086	Foot Valve, Valve Only, Stage I & II	1
35.	109-07-109	Treadle Foot Valve, Stage III Elite	1
36.	100-26-098	Air Inlet Valve	1

37.	104-21-171	Cleanout Port Gasket	1
38.	109-21-303	Mixing Tee, 3/4" Front Drain	1
39	100-01-030	Gravity Separator Plate, Stage I	1
39.	109-01-103	Separator Reclaimer, H/E Stage II	1
39.	109-01-101	Separator Reclaimer, H/E Stage III Elite	1

CRYSTALBLAST® PRO Stage II

1 Each LED 30 Watt Flood Light

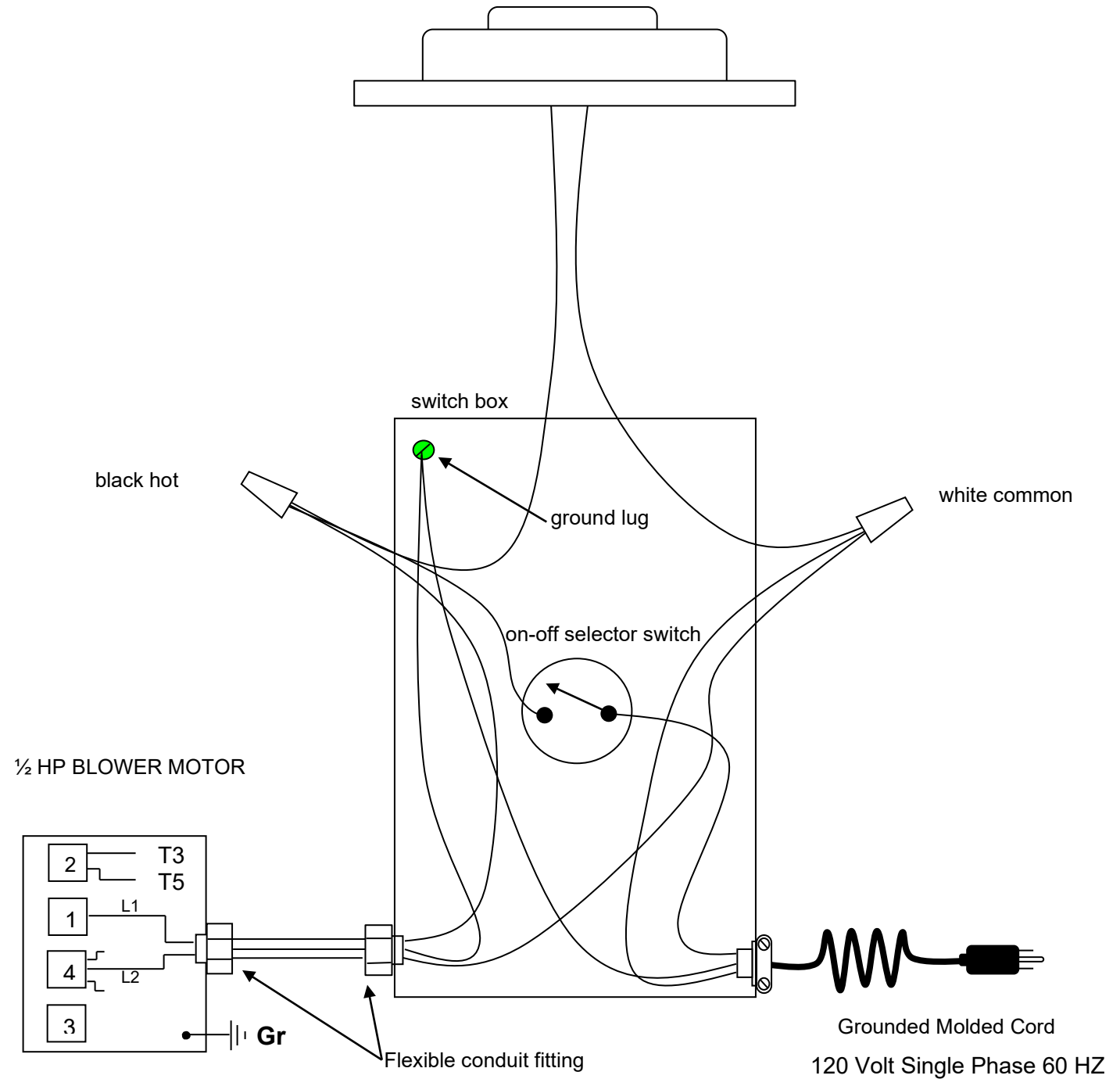

MOTOR C.W. ROTATION



CRYSTAL BLAST WARRANTY

Sandcarving Cabinets

Media Blast & Abrasives, Inc., hereinafter known as "Seller", warrants the equipment and products sold hereunder against defects in material and workmanship for a period of one year from the date of shipment to the original buyer.

Equipment, products or parts manufactured by others but furnished by seller will be repaired or replaced only to the extent of the original manufacturer's warranty (except motors).

The following conditions apply to limitations:

High wear parts are not covered; these parts include windows, window protector glass, nozzles, filters cartridge, abrasive hoses and other parts exposed to excessive abrasive contact and wear.

Warranty does not apply to misuse of the machine to include improper abrasive type use and or abrasive mesh size used in the equipment. No Media Blast equipment is used with sand; sand will void the machine warranty and is known to be a health hazard.

The machine warranty is not transferable and only applies to the original buyer.

This warranty does not cover damage because of accident, abuse, misuse, neglect, improper installation, improper maintenance, or the failure to operate in accordance with Media Blast & Abrasive's written instructions for machine operation and maintenance.

If a warranty issue does arise, a copy of the original invoice must be provided along with the machine's serial number located on the Media Blast® I.D. tag. Warranty claims must be requested by contacting Media Blast & Abrasive at 866 204 7068 and obtaining a RETURN GOODS AUTHORIZATION number (RGA). You must have an RGA # before any parts can be returned to Media Blast & Abrasives. The buyer is responsible for all shipping and labor costs incurred to remove and replace any warranty part and return that part to Media Blast & Abrasive.

Once Media Blast & Abrasives receives the part and it's determined to be defective a new replacement part will be shipped to the customer at no charge using standard UPS or USPS.